



eurocoin[®]

27EDECL4TG

31161533

Manual

Contents

1	Revision History.....	3
2	Description	4
3	Features	4
4	Monitor Components.....	4
5	Electrical Parameters.....	5
1.1	Input Characteristics.....	5
1.2	AD Board	5
6	Signal Input Format.....	6
7	LCD Specifications	7
7.1	General Features.....	7
7.2	Absolute Maximum Ratings.....	7
7.3	Optical Characteristics	8
7.4	Mechanical Characteristics	8
8	Display Inputs	9
9	LED Specification	10
9.1	SL-5050-60WS2812BS.....	10
9.2	Molex 43020-0600 connector	10
10	On Screen Display Board.....	11
10.1	OSD Board Buttons.....	11
10.2	Summary of OSD Menu.....	12
11	Glass Characteristics	13
12	Frame Characteristics	14
13	Assembly.....	15
14	Packaging	16
15	Optional LED Controller KIT	17

1 Revision History

Revision	Description of Update	Date
1.0	Final Product Specification	30.05.2024
1.1	Added Packaging	14.10.2024
1.1	Updated Assembly Drawing	14.10.2024
1.2	Updated Template	18.02.2025
1.2	Updated Optional LED controller KIT	18.02.2025

2 Description

27EDECEL4TG is a 27" Encased display which features Protective Glass and edge-facing Addressable LED illumination on all 4 sides. The high quality TFT-LCD panel is equipped with industrial electronics. AD board supports standard 3 point connections for VGA/ DVI and DP (DisplayPort) and offers standard 12 V operation.

3 Features

- 1920 x 1080 industrial TFT Display
- 12V Operation
- Signal Inputs: VGA / DVI / Display Port
- Encased Black Chassis
- Mounting points to the back of the Frame
- VESA 75X75mm; 100x100mm
- Additional strengthening supports
- On Screen Display (OSD) interface
- Addressable LED 5V
- 123 LEDs/Display
- 654.8 mm (L), 400.4 mm (W), 53 mm(H)

4 Monitor Components

Component	Description	Note
LCD Panel	P270HVN02.0	AUO
OSD Board	C-700	-
Electronics	K-1860	-
Metalwork	Encased	Color-Black
Glass	DS-00000246	2.8mm
LED	SL-5050-60WS2812BS	Molex 43020-0600
Acrylic	-	3.8 mm

5 Electrical Parameters

1.1 Input Characteristics

Power Input Connector

Connector: 2.5 DC12V Jack



Description	Signal	Unit	Min	Typical	Max	Remarks
Power In (12Vdc)						
	Input Voltage	Vdc		12	24	
	Consumption	Watt				< TBD (DPMS)

1.2 AD Board

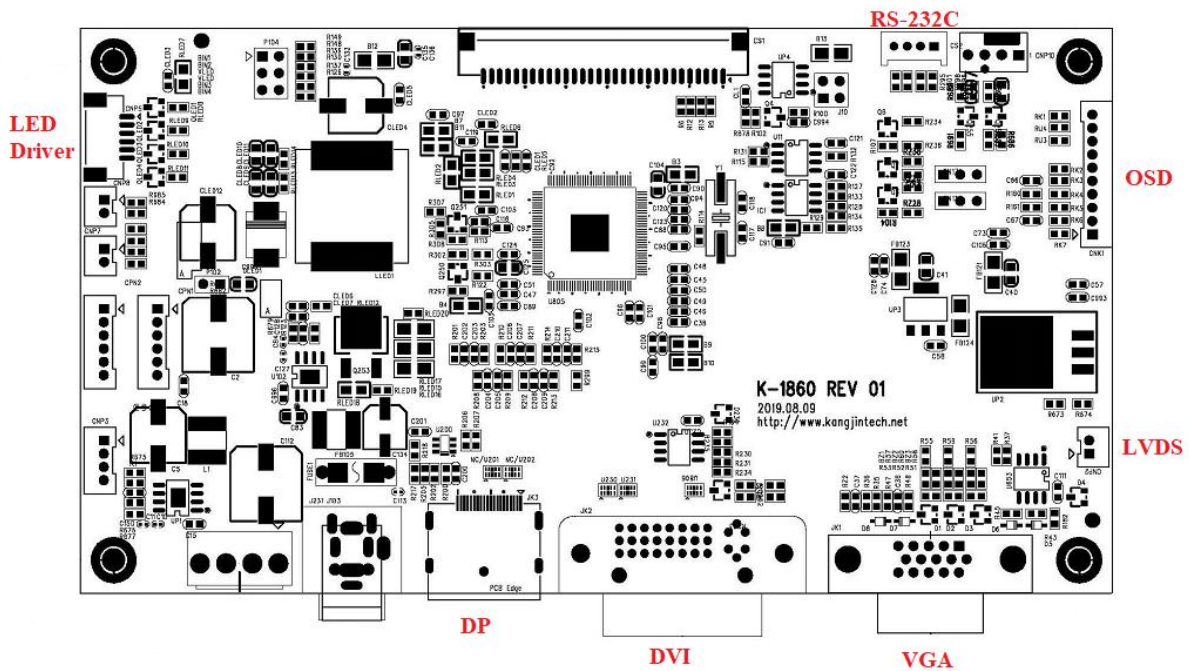

Description	Unit	Min	Typ	Max
Input Voltage	VDC		12	24
Analog RGB	Vp-p	0		0.7
Sync	VDC	0		5.5
H Frequency	KHz	31.43		80.00
V Frequency	Hz	56.25		75.03
Differential output	mVp-p	50		1200
Input clock freq	MHz	20		135
Signal Cable	D.P connector			
Signal Type	Base on DPRX technology			

6 Signal Input Format

The microprocessor measures the H-sync, V-sync and V-sync/H-sync polarity for RGB inputs, and uses this timing information to control all of the display operation to get the proper image on a screen.

This board can detect all VESA standard Graphic modes shown on the table below and provide more clear and stable image on a screen.

Table) RGB Input format

Character Mode	Pixel Freq. MHz	Horizontal Timing				Vertical Timing			
		Sync Polar	Freq. KHz	Total Pixel	Active Pixel	Sync Polar	Freq. Hz	Total Line	Active Line
640x350@70Hz	25.151	P	31.44	800	640	N	70.02	449	350
720x400 @70Hz	28.295	N	31.44	900	720	P	70.02	449	400
640x480 @60Hz	25.175	-	31.47	800	640	-	59.94	525	480
640x480 @67Hz	30.240	-	35.00	864	640	-	66.67	525	480
640x480 @72Hz	31.500	-	37.86	832	640	-	72.81	520	480
640x480 @75Hz	31.500	-	37.50	840	640	-	75.00	500	480
800x600 @56Hz	36.000	-	35.16	1024	800	-	56.25	625	600
800x600 @60Hz	40.000	-	37.88	1056	800	-	60.32	628	600
800x600 @72Hz	50.000	-	48.08	1040	800	-	72.19	666	600
800x600 @75Hz	49.500	-	46.88	1056	800	-	75.00	625	600
832x624 @74Hz	57.285	-	49.73	1152	832	-	74.55	667	624
1024x768@60Hz	65.000	-	48.36	1344	1024	-	60.00	806	768
1024x768@70Hz	75.000	-	56.48	1328	1024	-	70.07	806	768
1024x768@72Hz	75.235	-	57.70	1304	1024	-	72.30	798	768
1024x768@75Hz	78.750	-	60.02	1312	1204	-	75.03	800	768
1152x864@60Hz	88.566	-	54.00	1640	1152	-	60.00	900	864
1152x864@70Hz	93.930	-	62.62	1500	1152	-	69.58	900	864
1152x864@75Hz	108.000	-	67.50	1600	1152	-	75.00	900	864
1152x870@75Hz	100.000	-	68.68	1456	1520	-	75.00	915	870
1280x1024@60Hz	108.000	-	63.98	1688	1280	-	60.02	1066	1024
1280x1024@70Hz	124.995	-	74.40	1680	1280	-	69.99	1063	1024
1280x1024@72Hz	134.626	-	77.91	1728	1280	-	72.00	1082	1024
1280x1024@75Hz	135.001	-	79.98	1688	1280	-	75.03	1066	1024
1440x900@60Hz	106.500	-	55.90	1904	1440	+	60.01	932	900
1440x900@75Hz	136.750	-	70.51	1936	1440	+	75.02	940	900
1600x1200@60Hz	160.875	-	74.48	2160	1600	-	59.96	1242	1200
1680x1050@60Hz	119.000	-	64.72	1840	1680	-	60.02	1080	1050
1920x1080@60Hz	148.500		66.60	2160	1920		60.00	1125	1080
1920x1200@60Hz	154.110		74.10	2080	1920		59.99	1235	1200

7 LCD Specifications

7.1 General Features

Items	Units	Specifications
Screen Diagonal	[mm]	685.65 (27")
Pixel H x V		1920(x3) x 1080
Pixel Pitch	[um]	311.25 (per one trial) x311.25
Pixel Arrangement		R.G.B. Vertical island
Display Mode		VA Mode, Normally Black
White Luminance (Center)		300 (Typ.)
Contrast Ratio		3000 (Typ.)
Optical Response Time	[msec]	12 ms (Typ. on/off)
Power Consumption (VDD line + LED line)	[Watt]	26.8 watt, VDD Line: PDD (typ.), All white pattern at 60 Hz =5.1 W LED Line: RBLU (typ.)=21.78 W
Weight	[g]	2180 gram (Typ.)
Physical Size	[mm]	613.6(H)x356.85(V)x10.0(D) (Typ.)
Support Colour		16.7M colours (RGB 8-bit)
Surface Treatment		Anti-Glare 3H
Temperature Range		
Operating (Shipping)	[°C]	0 to +50
Storage	[°C]	-10 to +60
RoHS Compliance		RoHS Compliance
TCO Compliance		TCO 6.0 Compliance

7.2 Absolute Maximum Ratings

Parameters	Symbol	Values		Units	Notes
		Min	Max		
Logic/LCD Drive	VDD	4.5	5.5	[Volt]	<i>Note 1,2</i>
Operating Temperature	TOP	0	50	[°C]	<i>Note 3</i>
Glass Surface Temperature	TGS	0	65	[°C]	<i>Note 3</i> <i>Note 4</i>
Operating Humidity	HOP	5	90	[%RH]	<i>Note 3</i>
Storage Temperature	TST	-20	60	[°Cg]	
Storage Humidity	HST	5	90	[%RH]	

Note 1: With in Ta (25 °C)

Note 2: Permanent damage to the device may occur if exceeding maximum values

Note 3: Temperature and relative humidity range are shown as the below figure.

1. 90% RH Max (Ta≤39°C)

2. Max wet-bulb temperature at 39°C or less. (Ta≤39°C)

3. No condensation

Note 4: Function Judged only

7.3 Optical Characteristics

Items	Unit	Conditions	Min	Typ	Max	Notes
Viewing Angle	[degree]	Horizontal (Right)	150	178	-	2
		CR=10 (Left)			-	
		Vertical (Up)	150	178	-	
		CR=10 (Down)			-	
Contrast Ratio		Normal Direction	1800	3000	-	3
Response Time	[msec]	Raising Time (T_{rR})	-	7	17	4
		Falling Time (T_{rF})	-	5	7	
		Raising+Falling	-	12	24	
Colour/ Chromaticity Coordinates (CIE)		Red x	0.615	0.645	0.675	5
		Red y	0.300	0.330	0.360	
		Green x	0.285	0.315	0.345	
		Green y	0.590	0.620	0.650	
		Blue x	0.124	0.154	0.184	
		Blue y	0.034	0.064	0.094	
Colour Coordinates (CIE) White		White x	0.283	0.313	0.343	
		White y	0.299	0.329	0.359	
Central Luminance			240	300	-	6
Luminance Uniformity	[%]		75	80	-	7
Crosstalk (in 60Hz)	[%]				1.5	8
Flicker	dB				-20	9

7.4 Mechanical Characteristics

Description	Specificatin
Active Display Area	Horizontal 597.6 mm
	Vertical 336.15 mm
Weight	Typ: 2180 g
Surface Treatment	Hard coating (3H) Anti-glare treatment of the front polarizer

8 Display Inputs



VGA Input connector for 15P D-Sub

Pin No.	Symbol	Description	Pin No.	Symbol	Description
1	Red	Red, analog input	9	NC	Not connected
2	Green	Green, analog input	10	DGND	Detect connector
3	Blue	Blue, analog input	11	NC	Not connected
4	NC	Not connected	12	DDC Data	DDC Data
5	DGND	Digital ground	13	H-sync	Horizontal sync, input
6	AGND	Ground for Red return	14	V-sync	Vertical sync, input
7	AGND	Ground for Green return	15	DDC Clk	DDC Clk
8	AGND	Ground for Blue return			



Display Port Input connector for a DP Jack

Pin No.	Symbol	Description	Pin No.	Symbol	Description
1	Lane0P	Receive data0+	13	CONFIG1	AGND
2	GND	AGND	14	CONFIG1	AGND
3	Lane0N	Receive data0-	15	AUX_CHP	AUX+ communications
4	Lane1P	Receive data1+	16	GND	AGND
5	GND	AGND	17	AUX_CHN	AUX- communications
6	Lane1N	Receive data1-	18	HOT PLUG	HPD D.P
7	Lane2P	Receive data2+	19	RETURN	AGND
8	GND	AGND	20	DP_PWR	D.P +3.3V
9	Lane2N	Receive data2-	21	GND	AGND
10	Lane3P	Receive data3+	22	GND	AGND
11	GND	AGND	23	GND	AGND
12	Lane3N	Receive data3-	24	GND	AGND



DVI Input connector for a DVI Jack

Pin No.	Symbol	Description	Pin No.	Symbol	Description
1	RX2-	Receive data2-	13	RX3+	Not connected
2	RX2+	Receive data2+	14	5V	DVI 5V
3	GND	AGND	15	GND	AGND
4	RX4-	Not connected	16	HP	HOT PLUG
5	RX4+	Not connected	17	RX0-	Receive data0-
6	SCL	DVI DDC SCL IN	18	RX0+	Receive data0+
7	SDA	DVI DDC SDA IN	19	GND	AGND
8	VS	VS DVI	20	RX5-	Not connected
9	RX1-	Receive data1-	21	RX5+	Not connected
10	RX1+	Receive data1+	22	GND	AGND
11	GND	AGND	23	RXC+	Receive clk+
12	RX3-	Not connected	24	RXC-	Receive clk-

9 LED Specification

Clockwise Orientation

9.1 SL-5050-60WS2812BS

Items	Specification
LED Type	SMD5050
Input Voltage	DC 5V
LED QTY	60 LEDs/m
Colour	Addressable RGB
IC TYPE	WS2812B
LED Brand	SANAN
Power	12W/m
IP Grade	IP20 Non-waterproof
Storage Temperature	-40°C~+80°C
Operating Temperature	-30°C~+60°C
Lifespan	50000 Hours

Malfunction & Solutions		
Symptom	Possible Causes	Solutions
The brightness of the LED is not even	The power load exceeds the rated power of the power supply	Use the power supply with higher power or adopt the double-ended power-up mode
	Too many LED strips are connected	Adjust LED strip length for each chain to meet the maximum connectable length with single-ended power mode. The length is no longer than 5 meters

9.2 Molex 43020-0600 connector

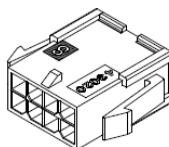

LED Lighting Control Port Pin Map IN					
#1	+5V	#2	DAT	#3	NC
#4	GND	#5	NC	#6	NC

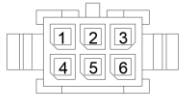

10 On Screen Display Board

10.1 OSD Board Buttons

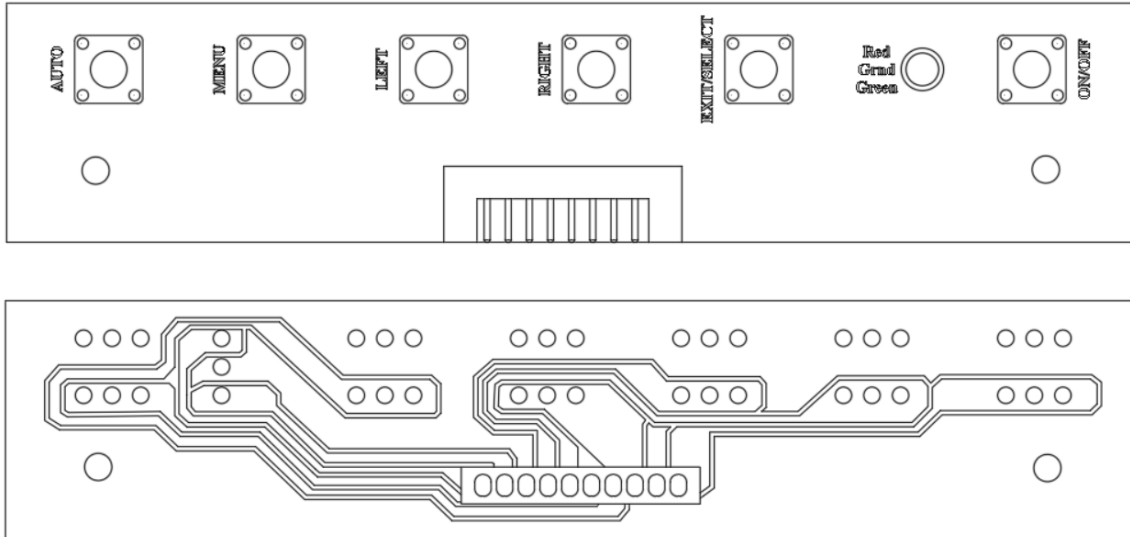

Keys	Button	Function
1	ON/OFF	Power on/off button - Turn power on or off
2	EXIT/SELECT	Menu of button - Submenu Select - Input Source Select (RGB/DP)
3	RIGHT	Adjust button - OSD Menu Up Moves the bar right to increase the adjustment
4	LEFT	Adjust button - OSD Menu Down - Moves the bar left to decrease the adjustment
5	MENU	Main menu on/move button - Show OSD menu on the screen - Exit the main menu or submenu
6	AUTO	Auto button - Auto adjust (Only VGA Mode)

10.2 Summary of OSD Menu

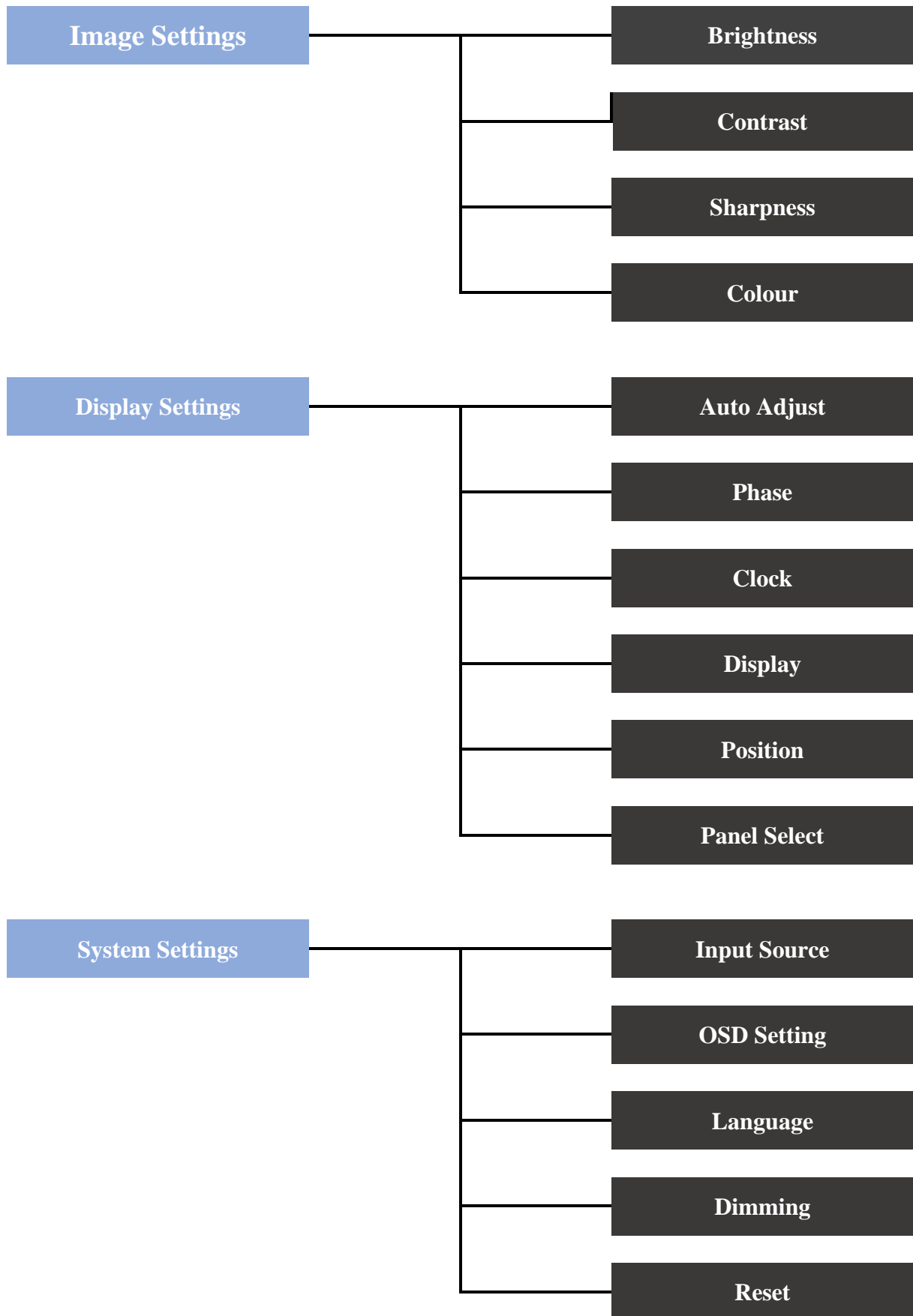

11 Glass Characteristics

Description	Glass Material	Surface treatment	Surface Hardness	TP Transparency	Product Standard
Specification	Soda-lime glass	No Coating	$\geq 6H$	$> 87\%$	RoHS Compliant

Front view

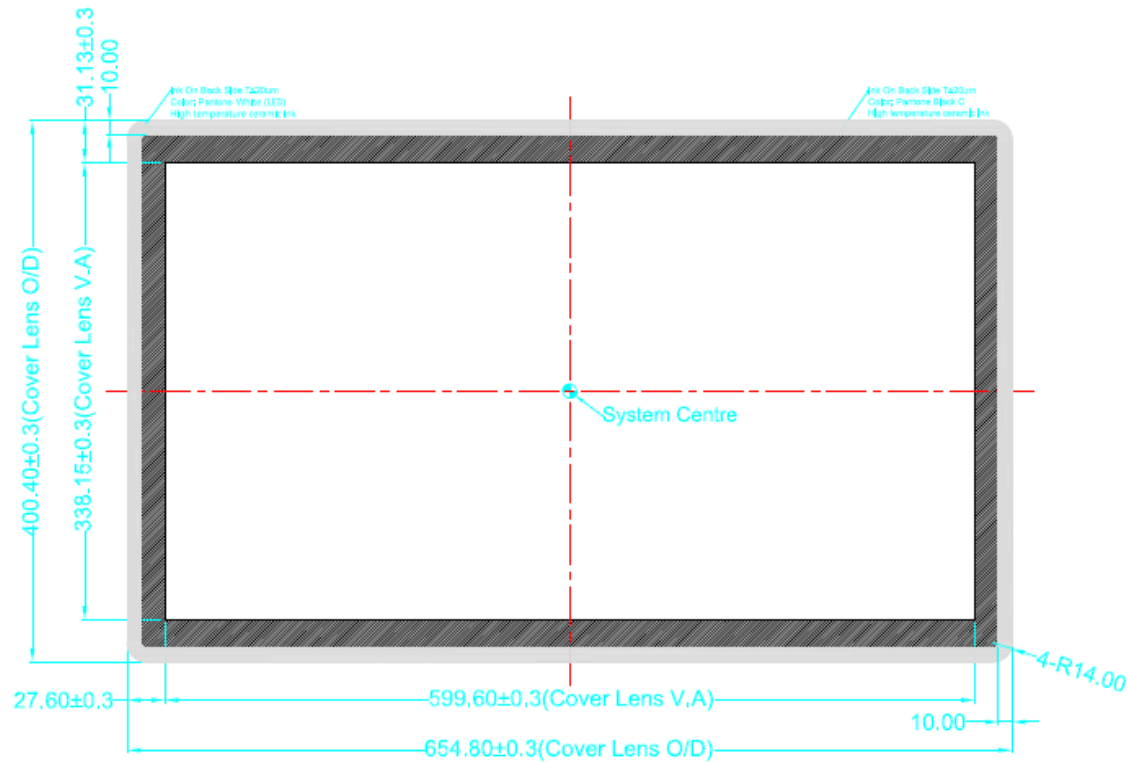

Side view

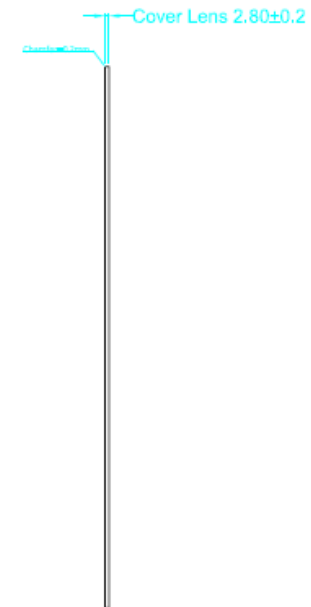

12 Frame Characteristics

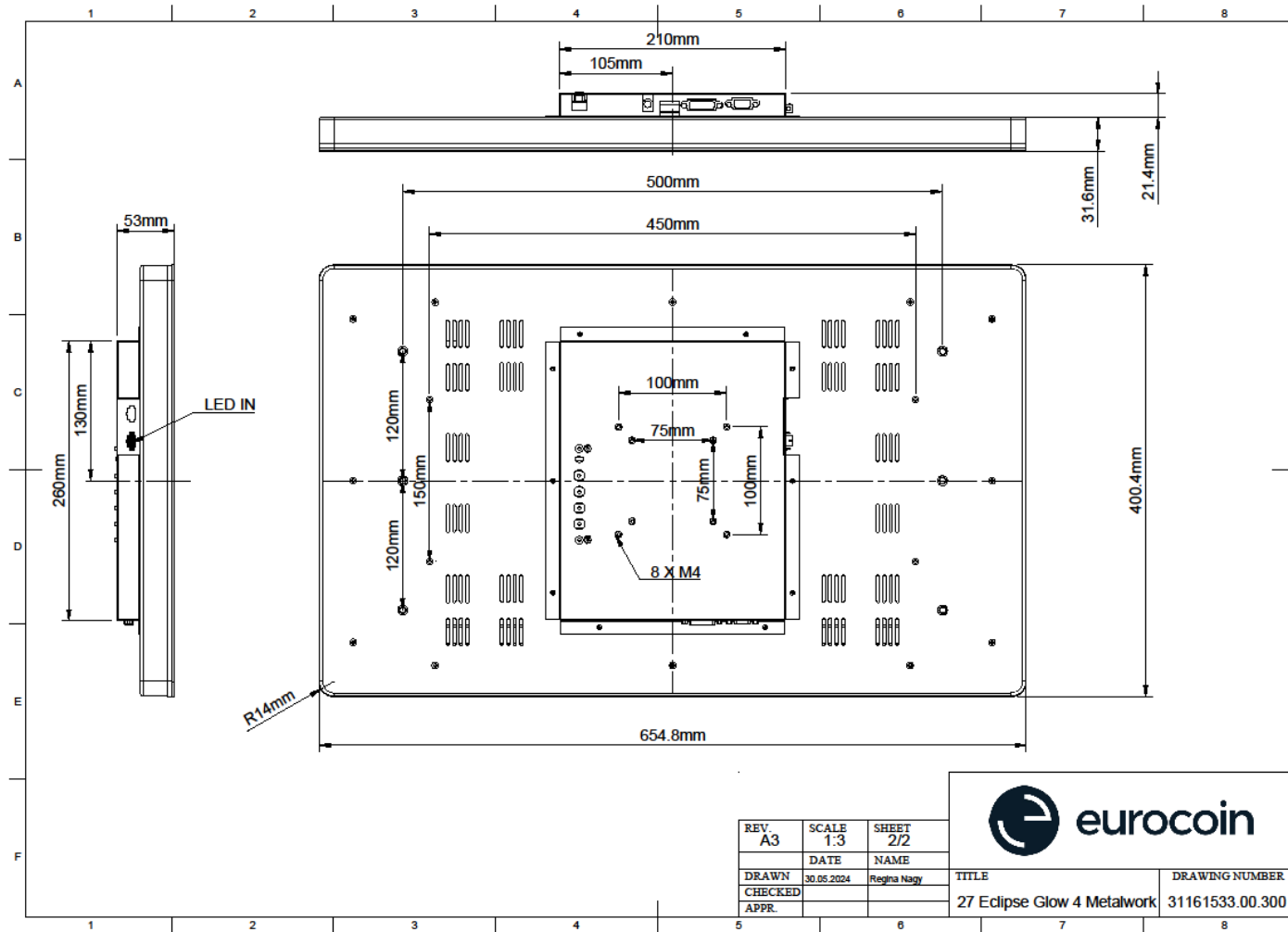

13 Assembly

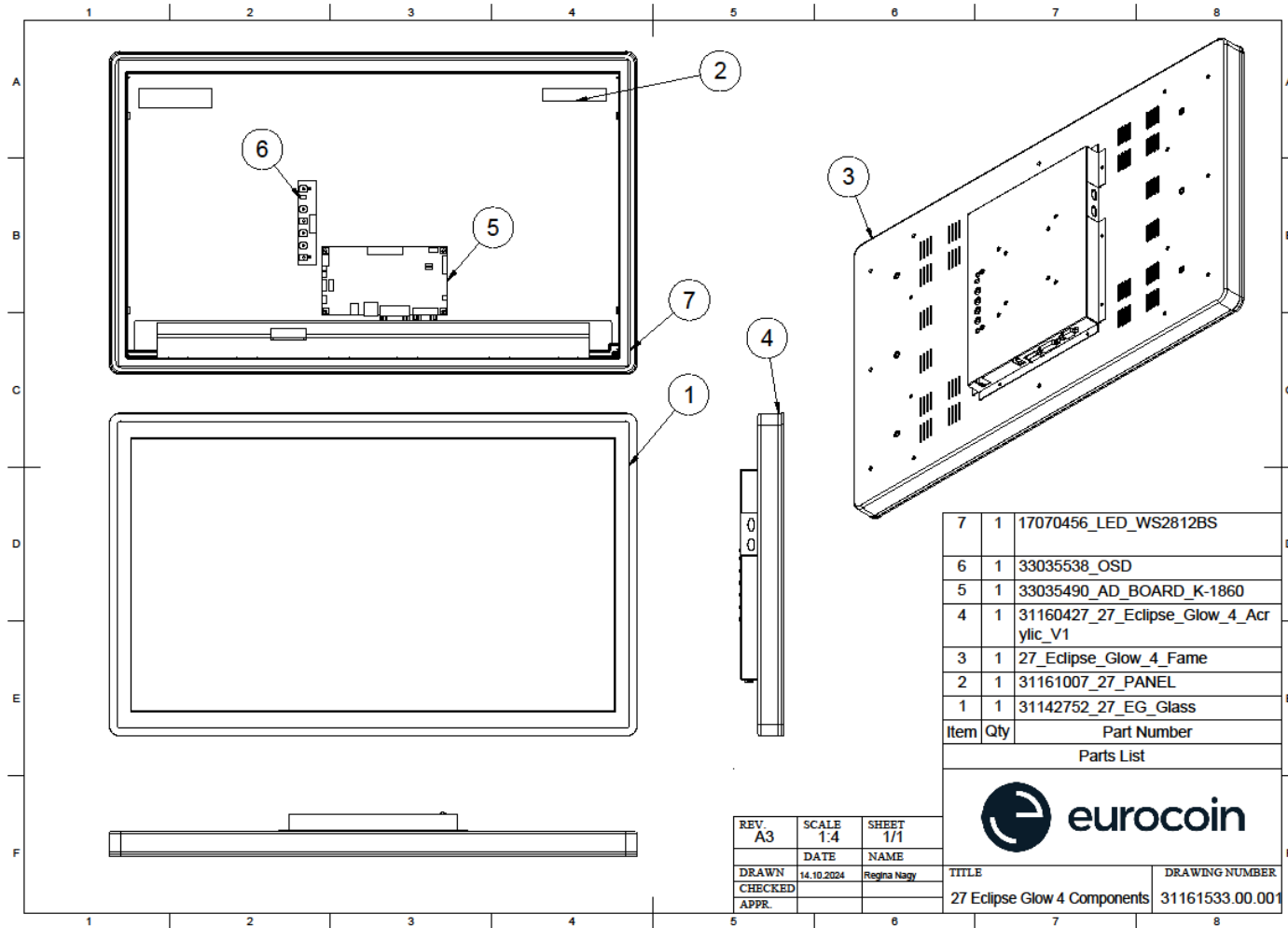

14 Packaging

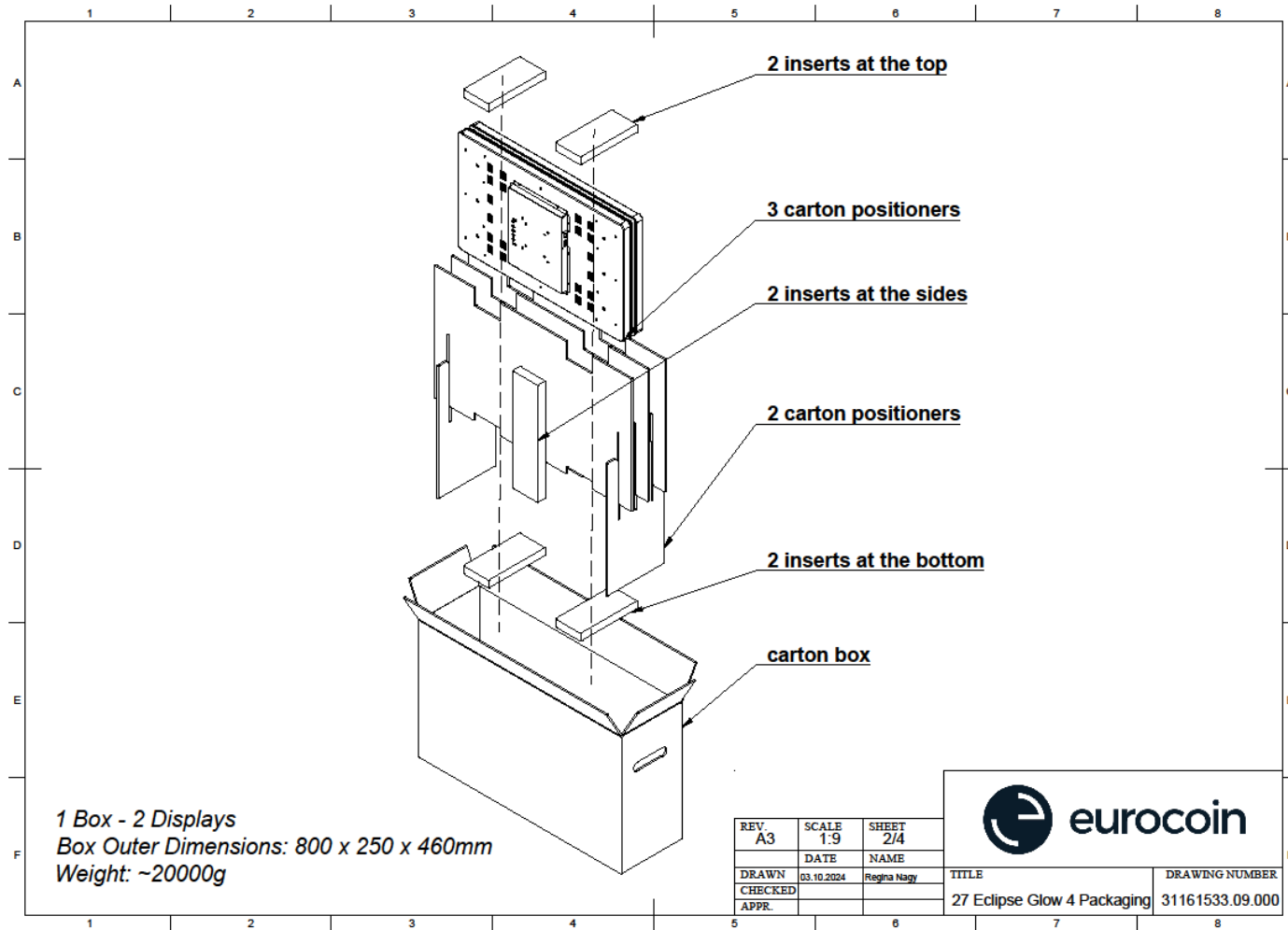

15 Optional LED Controller KIT

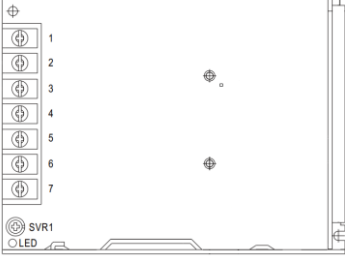
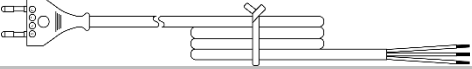
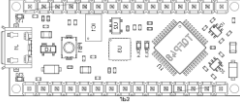
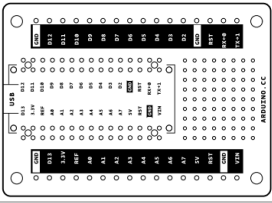
Single Arduino KIT		
17070510		
Component name	PC/KIT	Picture
5V PSU	1PC/KIT	
PSU CABLE	1PC/KIT	
ARDUINO	1PC/KIT	
ARDUINO ADAPTOR	1PC/KIT	
PSU TO ARDUINO TO LED	1PC/KIT	